



## BRIVIO SOFA

Design R&D Vittoria Frigerio

Il divano modulare Brivio si caratterizza per un design decisamente contemporaneo e dalle finiture luxury. Le forme classiche ed essenziali si esaltano nei volumi extra large dei cuscini seduta che poggiano su di una fine base rivestita in pelle. La vocazione sartoriale della raffinata collezione Vittoria Frigerio viene evidenziata da una cucitura dedicata sulla seduta del divano Brivio, che diventa un elemento caratterizzante e peculiare. La collezione di divani modulari Brivio si presta alle più svariate progettualità e idee d'arredo: composizioni classiche, lineari o angolari fino a soluzioni bifacciali per ambientazioni uniche e sofisticate. La collezione è arricchita da accessori con finiture preziose, come tavolini rivestiti in pelle con top in marmo, e braccioli di differenti misure per ogni soluzione d'arredo.

The Brivio modular sofa is characterized by a markedly contemporary design and luxury finishes. Its classic and essential forms are enhanced by the extra-large volumes of the seat cushions that lie on a fine leather-covered base. The sartorial vocation of Vittoria Frigerio collection is highlighted by a dedicated stitching on the seat of the Brivio sofa, which becomes a hallmark. Brivio modular sofa collection can meet any design and furnishing need: from classic, linear and corner compositions up to double-sided solutions, for unique and sophisticated settings. The collection is enriched by accessories with precious finishes, such as leather-covered small tables with marble tops, and armrests in different sizes for every design and space solution.

### BRIVIO

**Struttura:** legno multistrato imbottito in poliuretano espanso indeformabile rivestito in fibra sintetica termo-legata con vellutino.

**Cuscini schienale:** piuma d'oca (Assopiuma).

**Basamento:** legno rivestito esclusivamente in pelle.

**Bracciolo:** Il modello presenta due diverse tipologie di bracciolo, entrambe profonde come il divano.

La versione Low armrest ha il bracciolo più basso dello schienale.

La versione High armrest ha il bracciolo alto quanto lo schienale, per cui gli elementi "High armrest" possono essere utilizzati per la creazione di composizioni ad angolo.

**Rivestimento:** fisso, disponibile in tessuto o pelle.

**Trapuntatura:** disegno dedicato al modello, sulla seduta.

**Profilo liscio:** doppio, su schienale, braccioli e cuscini schienale, esclusivamente in Grosgrain Liscio. Su richiesta profilo nello stesso materiale e colore del rivestimento.

#### ACCESSORI:

**| volumi:** elementi volumi con struttura in multistrato di legno imbottito in poliuretano espanso indeformabile rivestito in fibra sintetica termo-legata con vellutino. Basamento in legno rivestito esclusivamente in pelle. Rivestimento fisso, disponibile in tessuto o pelle. Profilo doppio, esclusivamente in Grosgrain Liscio. Su richiesta profilo nello stesso materiale e colore del rivestimento.

**| tavolini:** struttura in metallo ricoperto in pelle a scelta. Basamento in legno rivestito in pelle a scelta. Ripiano inferiore in vetro retro-lacato nero opaco. Piano in marmo, disponibile tra quelli in collezione.

**Structure:** plywood padded with non-deformable polyurethane foam covered with synthetic fibre thermo-bonded with velveteen.

**Back cushions:** goose down (Assopiuma).

**Base:** wood covered exclusively in leather.

**Armrest:** The model features two different kinds of armrest, both as deep as the sofa.

In the Low armrest version, the armrest is lower than the backrest.

In the High armrest version, the armrest is as high as the backrest, therefore "High armrest" elements can be used for the building of corner compositions.

**Cover:** fix, available in fabric or leather.

**Quilting:** pattern dedicated to the model, on the seat.

**Plain piping:** double, on backrest, armrests and back cushions, exclusively in Grosgrain Plain. On demand piping in the same material and colour as the cover.

#### ACCESSORIES:

**| volume:** volume elements with structure in plywood padded with non-deformable polyurethane foam covered with synthetic fibre thermo-bonded with velveteen. wood covered exclusively in leather. Cover fix, available in fabric or leather. Piping double, exclusively in Grosgrain Plain. On demand piping in the same material and colour as the cover.

**| small table:** metal structure covered in leather at choice. Wood Base covered in leather at choice. Bottom shelf in black back-lacquered glass. Marble top, available among the ones from VF collection.

### BRIVIO DOUBLE

Gli elementi della collezione permettono l'aggancio degli articoli Seduta, consentendo la realizzazione di composizioni bifacciali. Viste le caratteristiche tecniche degli elementi Seduta, questi non possono essere utilizzati singolarmente, ma solamente in composizioni bifacciali.

The elements of the collection allow the fixing of Seat elements to create double-side compositions.

Due to the technical characteristics of the Seat elements, they cannot be used as free-standing, but only in double-sided compositions.



**BRIVIO BRACCIOLI E SEDUTE / ARMRESTS AND SEATS**

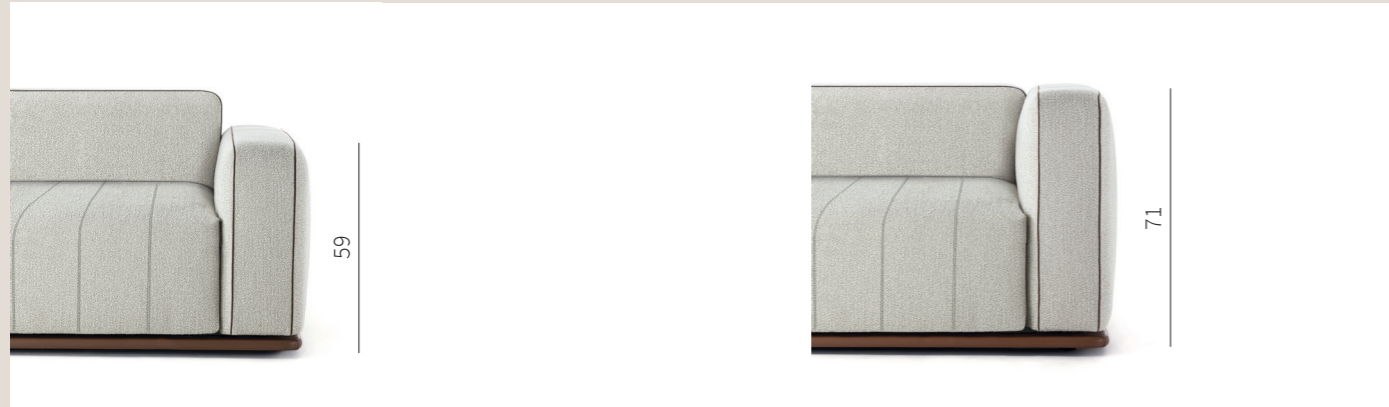

**BRACCIOLO BASSO / LOW ARMREST**

La versione **Low armrest** ha il bracciolo più basso dello schienale, H. 59 cm.

In the **Low armrest** version, the armrest is lower than the backrest, H. 59 cm.

**BRACCIOLO ALTO / HIGH ARMREST**

La versione **High armrest** ha il bracciolo alto quanto lo schienale, H. 71 cm.

In the **High armrest** version, the armrest is as high as the backrest, H. 71 cm.



**SEDUTA TRAPUNTATA / QUILTED SEAT**

Ogni elemento seduta presenta una trapuntatura verticale.

Each seating element features a vertical quilting.

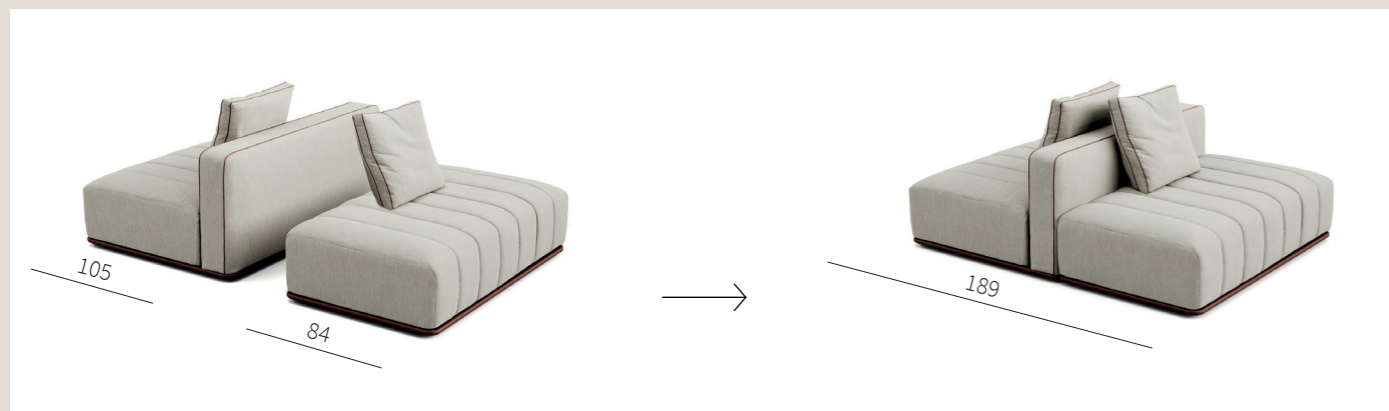

**BRIVIO DOUBLE**

Gli elementi della collezione permettono l'aggancio degli articoli "Seduta", consentendo la realizzazione di composizioni bifacciali.

The elements of the collection allow the fixing of "Seat elements" to create double-side compositions.

**BRIVIO ACCESSORI / ACCESSORIES**



**VOLUME / VOLUME**

Elementi di più dimensioni con basamento in pelle e rivestimento in tessuto o pelle da usare come elemento integrato o freestanding.

Element of different sizes with base in leather and cover in fabric or leather to be used as integrated element or freestanding.

**TAVOLINO / SMALL TABLE**

Tavolini di diverse dimensioni in metallo ricoperto in pelle da utilizzare come elemento integrato o freestanding.

Small tables in different sizes in metal covered in leather to be used as integrated element or as a freestanding piece.



**BASAMENTO IN PELLE / LEATHER BASE**

Basamento del divano rivestito esclusivamente in pelle.

Base of the sofa exclusively in leather.



**PROFILO / PIPING**

Profilo doppio, su schienale, braccioli e cuscini schienale, esclusivamente in Grosgrain Liscio. Su richiesta profilo nello stesso materiale e colore del rivestimento.

Double piping, on backrest, armrests and back cushions, exclusively in Grosgrain Plain. On demand piping in the same material and colour as the cover.

**BRIVIO SOFA**  
Design R&D Frigerio

**B BRACCILO BASSO / LOW ARMREST / h. 59 cm**

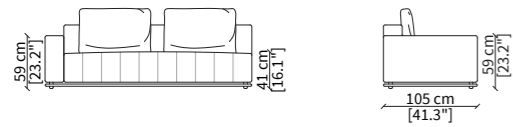

**A BRACCILO ALTO / HIGH ARMREST / h.71 cm**

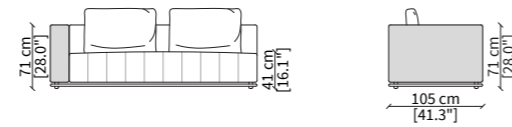

**DIVANI / SOFAS**

VF20000B VF20001B VF20002B  
VF20000A VF20001A VF20002A

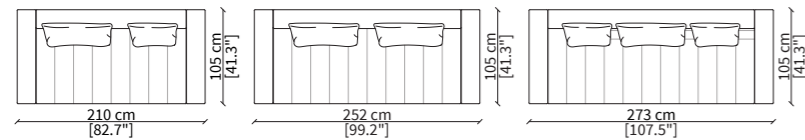

**ELEMENTI TERMINALI / TERMINAL ELEMENTS**

VF20003B VF20004B VF20005B VF20006B VF20007B VF20008B  
VF20003A VF20004A VF20005A VF20006A VF20007A VF20008A

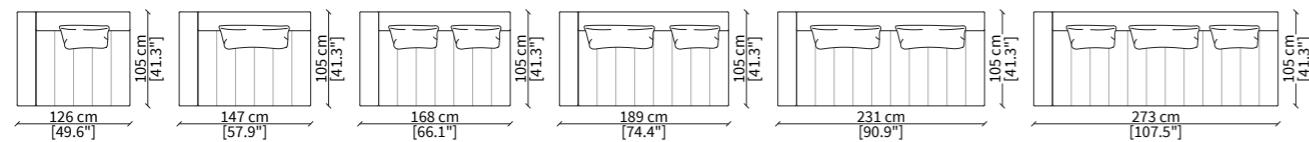

**ELEMENTI CENTRALI / CENTRAL ELEMENTS**

VF20009 VF20010 VF20011 VF20012 VF20013 VF20014 VF20015

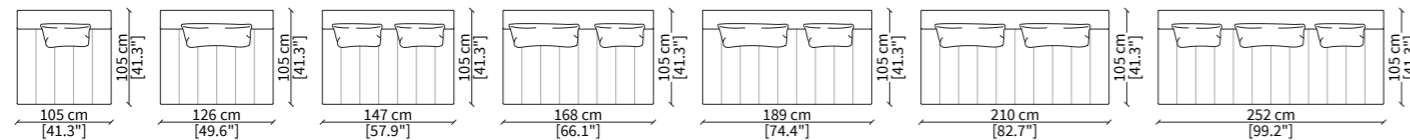

**ELEMENTI DORMEUSE / DORMEUSE ELEMENTS**

VF20016B VF20017B  
VF20016A VF20017A

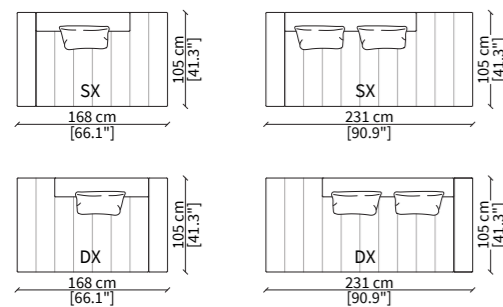

Dimensioni espresse in cm se non diversamente indicato.  
L'Azienda si riserva il diritto di apportare modifiche ai modelli senza preavviso.  
Tolleranza sulle misure indicate di +/- 2%.

Dimensions in centimeter if not differently indicated.  
The Company reserves the right to change the models without any advance notice.  
Tolerance on the given sizes +/- 2%.

**BRIVIO SOFA**  
Design R&D Frigerio

**ELEMENTI CENTRALI DORMEUSE / CENTRAL DORMEUSE ELEMENTS**

VF20018 VF20019

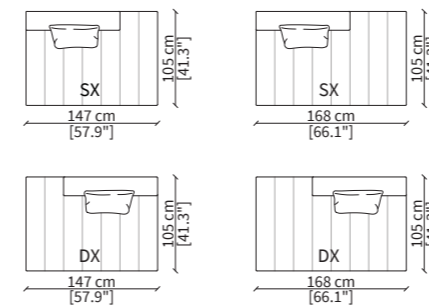

**CHAISES LONGUE**

VF20023B  
VF20023A

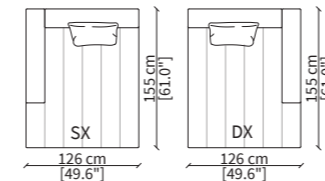

**CHAISE LONGUE CENTRALE / CENTRAL CHAISE LONGUE**

VF20022

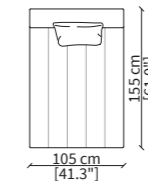

**ELEMENTI TERMINALI COMFORT / COMFORT TERMINAL ELEMENTS**

VF20060B  
VF20060A

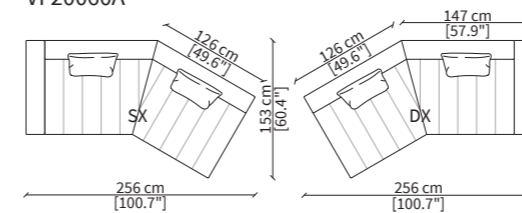

**ELEMENTO CENTRALE COMFORT / COMFORT CENTRAL ELEMENT**

VF20020

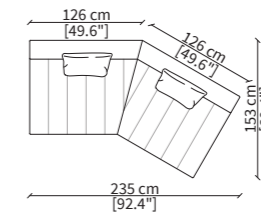

**ELEMENTI DORMEUSE COMFORT / COMFORT DORMEUSE ELEMENTS**

VF20021

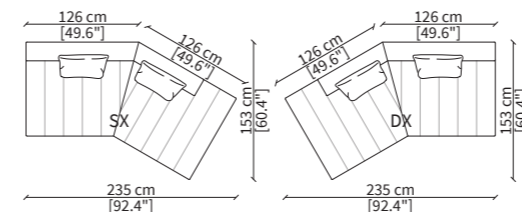

**ELEMENTO ANGOLO / CORNER ELEMENT**

VF20024

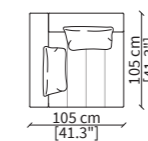

Dimensioni espresse in cm se non diversamente indicato.  
L'Azienda si riserva il diritto di apportare modifiche ai modelli senza preavviso.  
Tolleranza sulle misure indicate di +/- 2%.

Dimensions in centimeter if not differently indicated.  
The Company reserves the right to change the models without any advance notice.  
Tolerance on the given sizes +/- 2%.

**BRIVIO SOFA**

Design R&D Frigerio

ELEMENTI SEDUTA PER BRIVIO DOUBLE / SEAT ELEMENTS FOR BRIVIO DOUBLE

**B BRACCIOLO BASSO / LOW ARMREST / h. 59 cm**

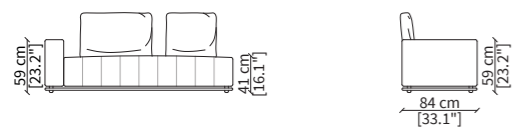

**A BRACCIOLO ALTO / HIGH ARMREST / h.71 cm**

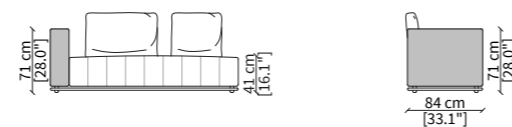

ELEMENTI SEDUTA TERMINALE / TERMINAL SEAT ELEMENTS

VF20025B VF20026B VF20027B VF20028B VF20029B  
VF20025A VF20026A VF20027A VF20028A VF20029A

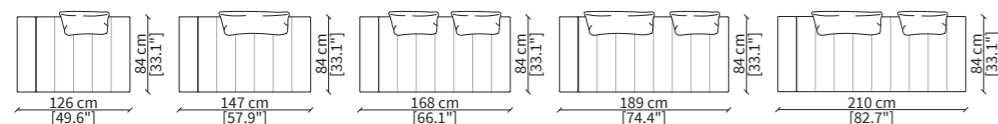

ELEMENTI SEDUTA CENTRALI / CENTRAL SEAT ELEMENTS

VF20030 VF20031 VF20032 VF20033 VF20034 VF20035

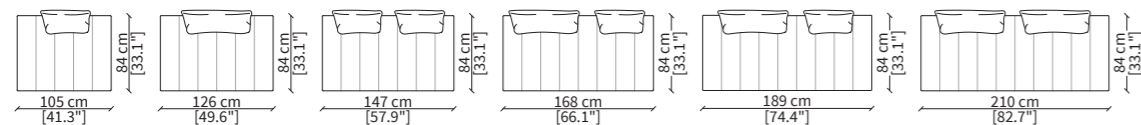

ELEMENTI SEDUTA CHAISE LONGUE / CHAISE LONGUE SEAT ELEMENTS

VF20037B  
VF20037A

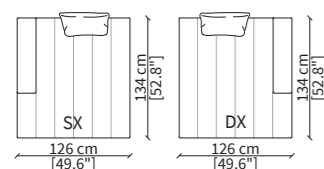

ELEMENTI SEDUTA CENTRALI CHAISE LONGUE / CENTRAL CHAISE LONGUE SEAT ELEMENTS

VF20036

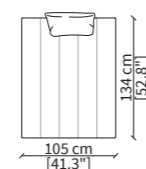

Dimensioni espresse in cm se non diversamente indicato.  
L'Azienda si riserva il diritto di apportare modifiche ai modelli senza preavviso.  
Tolleranza sulle misure indicate di +/- 2%.

Dimensions in centimeter if not differently indicated.  
The Company reserves the right to change the models without any advance notice.  
Tolerance on the given sizes +/- 2%.

**BRIVIO SOFA**

Design R&D Frigerio

POUFS

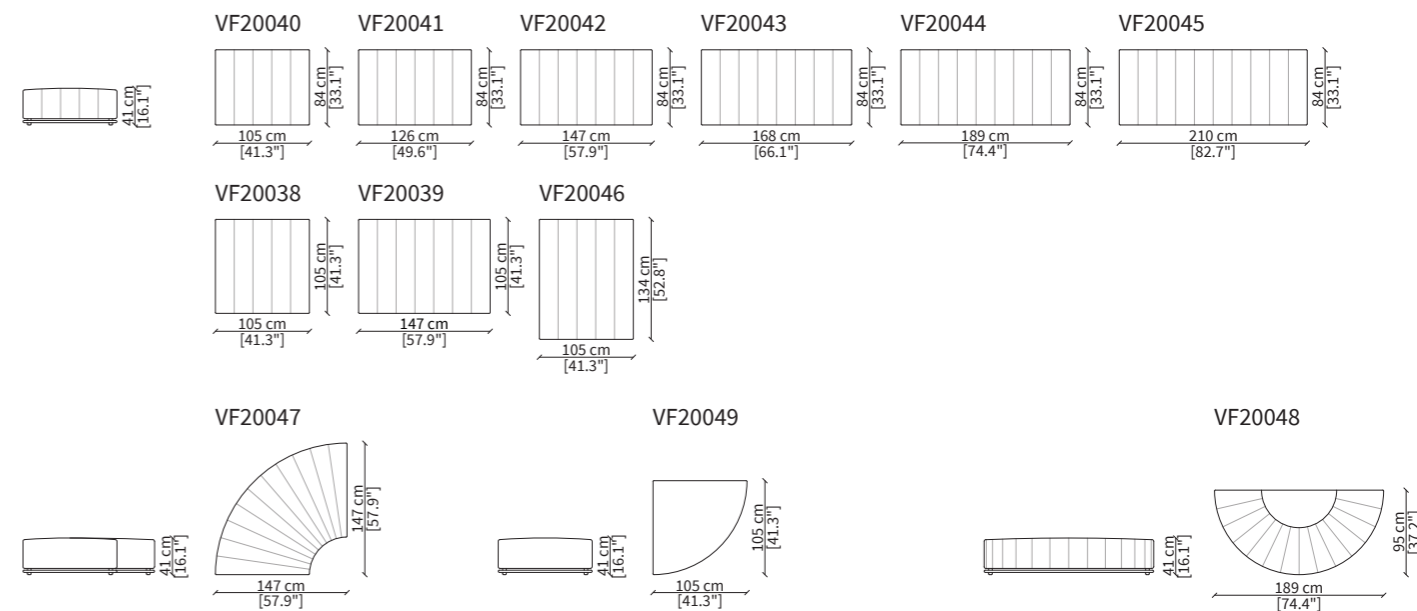

VOLUMI / VOLUMES

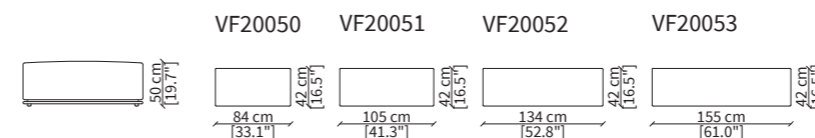

TAVOLINI / SMALL TABLES

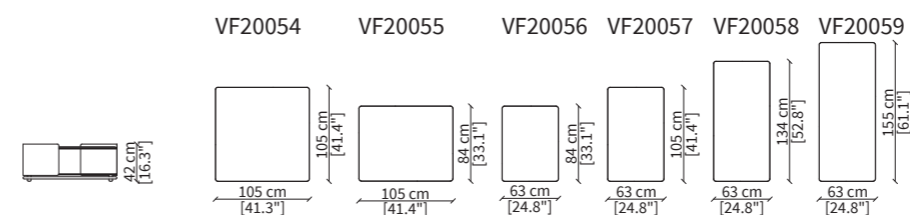

CUSCINI / CUSHIONS

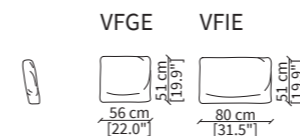

Dimensioni espresse in cm se non diversamente indicato.  
L'Azienda si riserva il diritto di apportare modifiche ai modelli senza preavviso.  
Tolleranza sulle misure indicate di +/- 2%.

Dimensions in centimeter if not differently indicated.  
The Company reserves the right to change the models without any advance notice.  
Tolerance on the given sizes +/- 2%.

**ESEMPI DI COMPOSIZIONE AD ANGOLO CON BRACCIOLO BASSO /**  
EXAMPLES OF CORNER COMPOSITIONS WITH LOW ARMREST

Le composizioni ad angolo possono essere così realizzate:  
Corner composition can be built as follows:

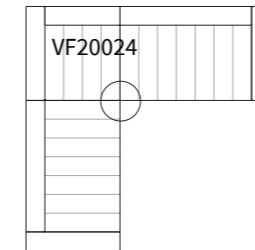

1. utilizzando l'angolo (art. **VF20024**) per un allineamento preciso delle sedute.

1. by using the corner (art. **VF20024**) for a perfect alignment of the seats.

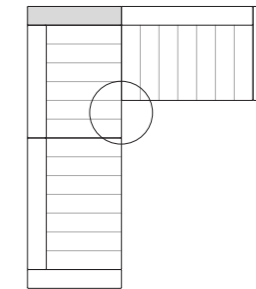

2. utilizzando un terminale con bracciolo alto per creare un angolo. Sugeriamo l'aggiunta di un cuscino schienale per maggior comfort.

2. by using a terminal with high armrest to create a corner . We recommend adding an extra back cushion for a better comfort.

**ESEMPI DI COMPOSIZIONE AD ANGOLO CON BRACCIOLO ALTO /**  
EXAMPLES OF CORNER COMPOSITIONS WITH HIGH ARMREST

Le composizioni ad angolo possono essere così realizzate:  
Corner composition can be built as follows:

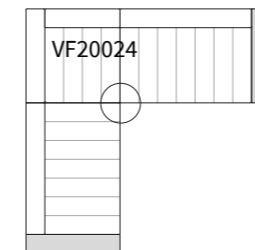

1. utilizzando l'angolo (art. **VF20024**) per un allineamento preciso delle sedute.

1. by using the corner (art. **VF20024**) for a perfect alignment of the seats.

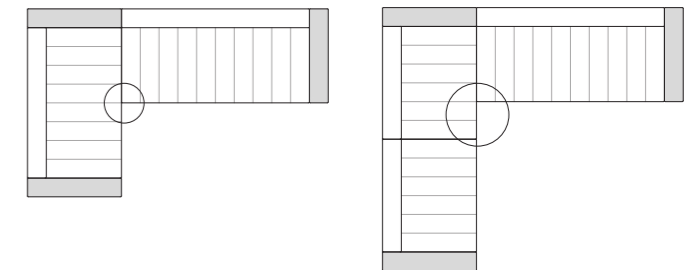

2. accostando tra loro gli elementi con bracciolo alto. Sugeriamo l'aggiunta di un cuscino schienale per maggior comfort.

2. by combining the elements with high armrest. We recommend adding an extra back cushion for a better comfort.

**BRIVIO SOFA**  
Design R&D Frigerio

COMPOSIZIONE 1 / COMPOSITION 1

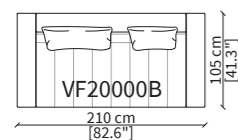

CODICI / CODES: **VF20000**

COMPOSIZIONE 2 / COMPOSITION 2

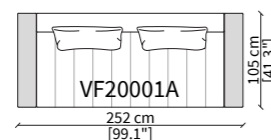

CODICI / CODES: **VF20001A**

COMPOSIZIONE 3 / COMPOSITION 3

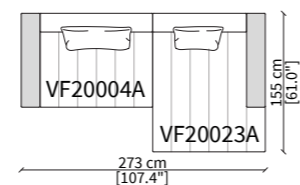

CODICI / CODES: **VF20004A, VF20023A**

COMPOSIZIONE 4 / COMPOSITION 4

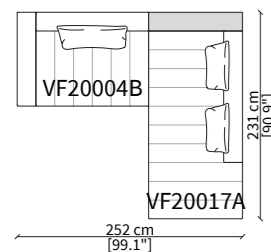

CODICI / CODES: **VF20004B, VF20017A**

COMPOSIZIONE 5 / COMPOSITION 5

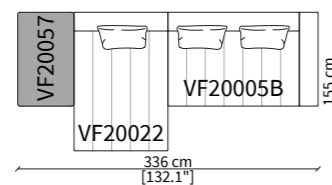

CODICI / CODES: **VF20057, VF20022, VF20005B**

COMPOSIZIONE 6 / COMPOSITION 6

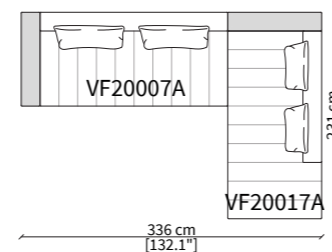

CODICI / CODES: **VF20007A, VF20017A**

COMPOSIZIONE 7 / COMPOSITION 7

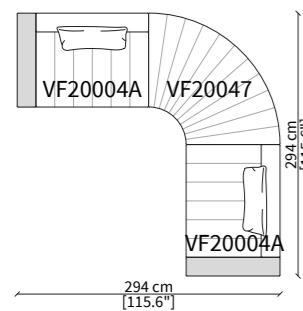

CODICI / CODES: **VF20004A x 2, VF20047**

COMPOSIZIONE 8 / COMPOSITION 8

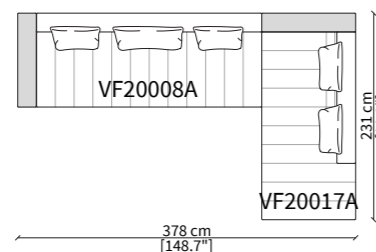

CODICI / CODES: **VF20008A, VF20017A**

COMPOSIZIONE 9 / COMPOSITION 9

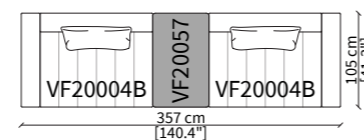

CODICI / CODES: **VF20004B x 2, VF20057**

Dimensioni espresse in cm se non diversamente indicato.  
L'Azienda si riserva il diritto di apportare modifiche ai modelli senza preavviso.  
Tolleranza sulle misure indicate di +/- 2%.

Dimensions in centimeter if not differently indicated.  
The Company reserves the right to change the models without any advance notice.  
Tolerance on the given sizes +/- 2%.

**BRIVIO SOFA**  
Design R&D Frigerio

COMPOSIZIONE 10 / COMPOSITION 10

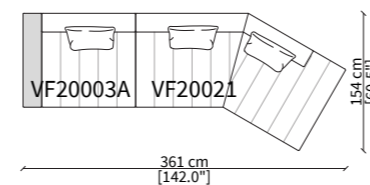

CODICI / CODES: **VF20003A, VF20021**

COMPOSIZIONE 11 / COMPOSITION 11

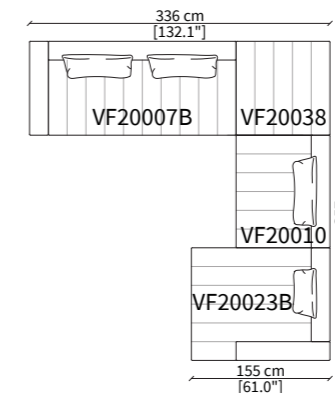

CODICI / CODES: **VF20007B, VF20038, VF20010, VF20023B**

COMPOSIZIONE 12 / COMPOSITION 12

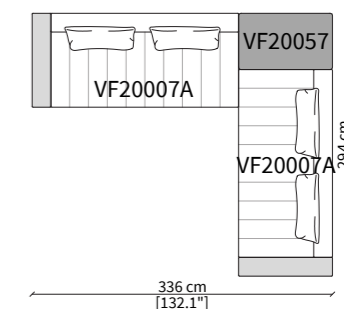

CODICI / CODES: **VF20007A x 2, VF20057**

COMPOSIZIONE 13 / COMPOSITION 13

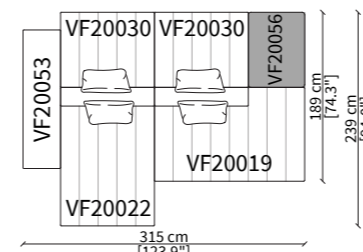

CODICI / CODES: **VF20053, VF20030 x 2, VF20056, VF20022, VF20019**

COMPOSIZIONE 14 / COMPOSITION 14

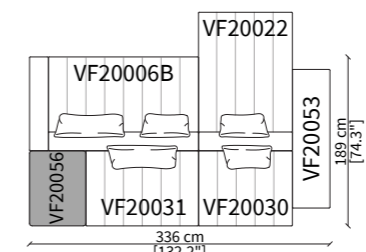

CODICI / CODES: **VF20006B, VF20022, VF20053, VF20056, VF20031, VF20030**

COMPOSIZIONE 15 / COMPOSITION 15

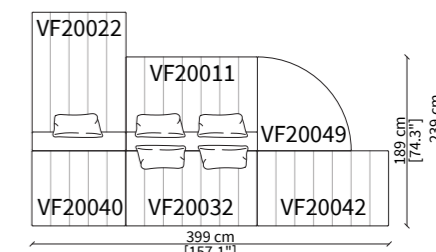

CODICI / CODES: **VF20022, VF20011, VF20049, VF20040, VF20032, VF20042W**

COMPOSIZIONE 16 / COMPOSITION 16

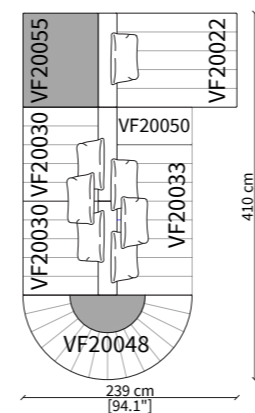

CODICI / CODES: **VF20055, VF20030 x 2, VF20048, VF20022, VF20050 VF20033**

COMPOSIZIONE 17 / COMPOSITION 17

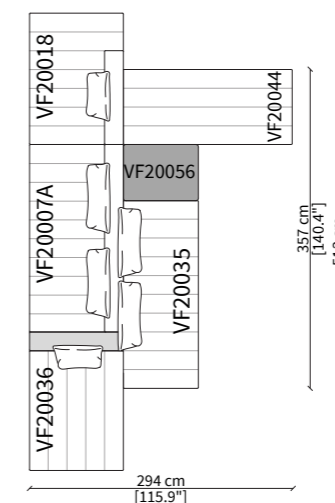

CODICI / CODES: **VF20018, VF20007A, VF20036, VF20044, VF20056, VF20035**

COMPOSIZIONE 18 / COMPOSITION 18

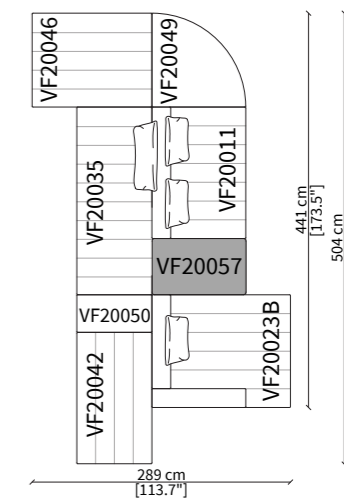

CODICI / CODES: **VF20046, VF20035, VF20050, VF20042, VF 20049, VF20011, VF20057, VF20023B**

Per la gamma completa di materiali è possibile consultare il nostro sito web [www.vittoriafrigerio.it](http://www.vittoriafrigerio.it)  
The full range of materials can be found on our website at [www.vittoriafrigerio.it](http://www.vittoriafrigerio.it)

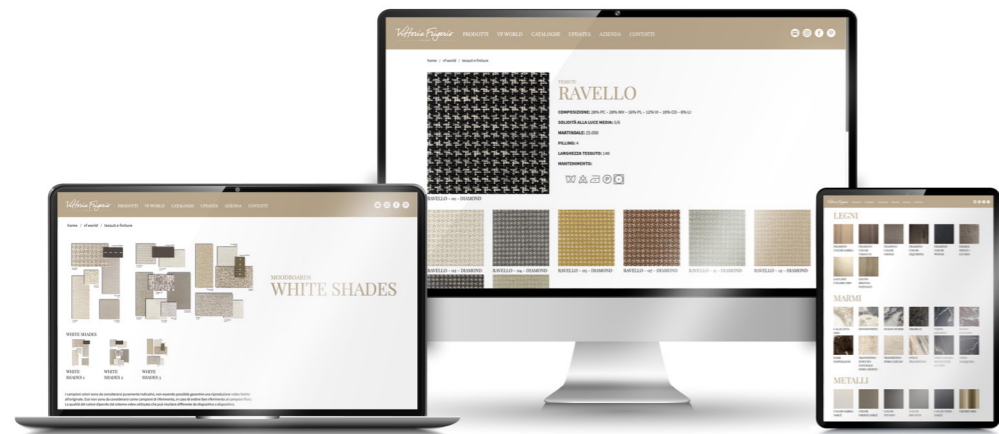

[WWW.VITTORIAFRIGERIO.IT](http://WWW.VITTORIAFRIGERIO.IT)